

ZTE F160

User Manual

LEGAL INFORMATION

Copyright © 2012 MTC CORPORATION.

All rights reserved.

No part of this publication may be excerpted, reproduced, translated or utilized in any form or by any means, electronic or mechanical, including photocopying and microfilm, without the prior written permission of ZTE Corporation.

The manual is published by ZTE Corporation. We reserve the right to make modifications on print errors or update specifications without prior notice.

Version No. : R1.0

Edition Time : 2012.09

Manual No. : 07958450XXXX

Contents

Getting Started	7
Phone Overview	7
Keys and Parts.....	7
Keypad Functions	7
Indicators and Icons	8
Starting Up.....	9
Installing the Battery	9
Removing the Battery	10
Inserting the SIM card.....	10
Removing the SIM Card	11
Inserting the Memory Card	11
Removing the Memory Card.....	12
Connecting Accessories	12
Power On/Off.....	13
Charging Your Phone.....	13
Quick Operation	14
Standby Mode	14
Navigation Keys.....	16
Soft Keys.....	16
Back and Exit Keys.....	16
Basic Operation.....	16
Menu	16
Navigating Your Phone.....	17
Setting the Date and Time.....	18
Keypad Lock	18
Getting Help.....	18
Help in your phone.....	18
Help in the User Manual	18
Text Input.....	19
Text Mode	19
Current Text Mode.....	19
Changing the Input Mode.....	19
Abc/ABC/abc Mode.....	19
123 Mode	19
En	19
Special Symbols	19
Calls	20
Voice Calls	20
Making a Voice Call	20

Making a Voice Call from Contacts	20
Making a Voice Call from Call History	20
Voice Call Options	20
Speed Dial	20
Making a Speed Dial Call	20
Speed Dial Settings	21
Receiving/Rejecting Calls	21
Adjusting the Volume	21
Call History	21
Call Settings	21
Starting Call forwarding.....	21
Cancelling Call forwarding	22
Starting Call Waiting.....	22
Starting Call Barring	22
Cancel all call barring	22
Changing the Call Barring Password	22
Send My Number	23
Messages	24
Text Messages	24
SMS Settings	24
Sending a New SMS	24
Receiving an SMS	24
Multimedia Message	25
MMS Settings	25
Sending a new MMS	25
Email	26
Email Settings	26
Sending an Email	26
Voice Mail	27
Voice Mail Settings.....	27
Receiving a Voice Mail.....	27
Message Boxes.....	27
Push Messages	27
Contacts	28
Contacts	28
Adding a Contact.....	28
Contact Options.....	28
Connectivity	29
Mobile Network Select	29
Bluetooth	29

Enabling Bluetooth	29
My Devices	30
Sending Data	30
Receiving Data	30
Internet.....	31
Setting up the Internet Connection.....	31
Surfing the Internet	31
Entertainment	32
Pictures	32
Taking a Photo	32
Viewing Pictures	32
Music	32
Playing a Music File	32
Managing a Playlist.....	33
Video	33
Recording a Video.....	33
Playing Videos	33
Streaming URL	33
Playing Streaming Media.....	33
Recorder	34
Tools	35
Alarm	35
Calendar	35
Stopwatch	35
World Time.....	35
Calculator.....	35
Converter	35
GPS.....	35
Personalize Your Phone	36
Profiles	36
Basic Settings	36
Display Settings	36
Connections	36
Phone Security	38
Security Codes	38
Phone Password	38

PIN Codes	38
PUK Codes.....	38
Fixed dial numbers.....	39
FDN List	39
Network Unlcok.....	39
File Manager	40
Managing Folders.....	40
Space Management.....	40
Care and Maintenance	41
General Care.....	41
Aircraft Safety.....	42
Hospital Safety	42
General Guidelines.....	42
Road Safety	43
Vehicles Equipped with an Airbag.....	43
Third Party Equipment.....	43
Emergency Service	43
Declaration of Conformity	44
Privacy Information.....	44
Copyright Notice	44
IC compliance.....	44
Troubleshooting and FAQs	45
Specifications.....	47
Glossary.....	48

Getting Started

Phone Overview

Keys and Parts

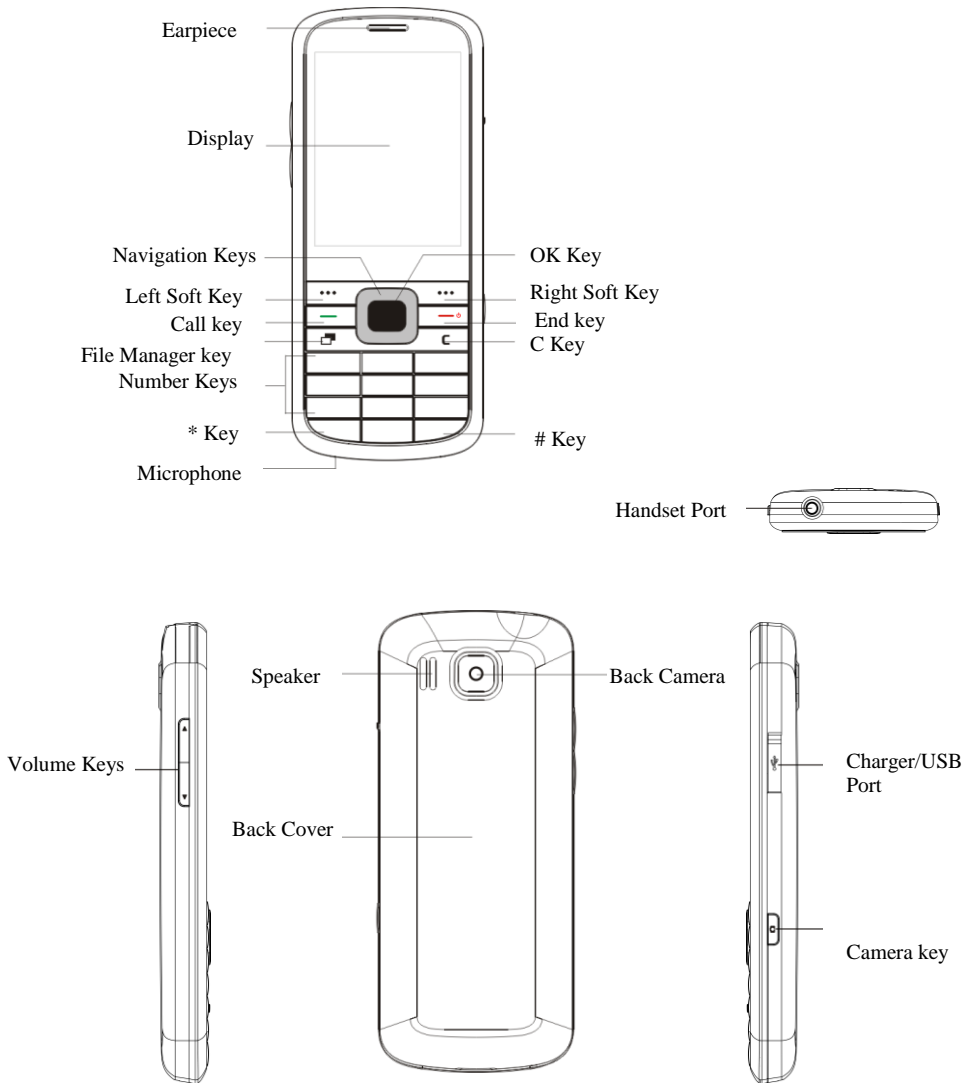

























Keypad Functions

Key	Function Description
Soft Key	The bottom line of the display shows the options that can be selected using the Left and Right Soft Keys . The options change depending on the application/function being used.
Call Key	• Press the Call Key to dial or answer calls.

Key	Function Description
	<ul style="list-style-type: none"> In standby mode: Press the Call Key to show a list of All Recent calls.
End Key	<ul style="list-style-type: none"> Press and hold the End Key to turn the phone on/off. Press the End Key to end a call. Press the End Key to reject an incoming call. Press the End Key to cancel dialing. Press the End Key to return to the Main Menu or standby mode.
Clear Key	<ul style="list-style-type: none"> Press the C Key to delete the message or file. Press the C Key once to delete the character on the left of the cursor when entering text or numbers. Press and hold the C Key to delete all characters during text entry.
Navigation Key	<ul style="list-style-type: none"> In standby mode: Used as hot keys to activate pre-set functions. In lists, messages and menus: Used to scroll up, down, left and right.
OK Key	In lists and menus: Press the OK Key to start an application/function.
Number Keys	<ul style="list-style-type: none"> Press the number keys to enter a phone number. Press and hold keys 2 to 9 to dial the associated speed dial contact.
* Key	<ul style="list-style-type: none"> Press the * Key to enter *. Press and hold the * Key to lock the keypad. In an editing screen: Press the * Key to enter punctuation and symbols.
# Key	<ul style="list-style-type: none"> Press the # Key to enter #. In an editing screen: Press the # Key to change the input method. In standby mode: Press and hold the # Key to activate/deactivate meeting mode with vibration.

Indicators and Icons

	Signal strength		Alarm
	GSM network		Bluetooth on
	WCDMA network		EDGE network
	New SMS		Battery status
	SMS memory is full.		Meeting (vibrate and silent) mode
	New MMS		Vibrate mode
	MMS memory is Full		Silence
	New E-mail		Flight mode
	E-mail memory is Full		Missed voice call
	New Wap Push Message		microSD card inserted

	Wap Push Message memory is Full		Data transfer in progress
	Roaming		Data transfer in attaching

Starting Up

Installing the Battery



Notes:

- ▶ The phone automatically switches off if the battery power is too low.
- ▶ If you are not going to use the battery for a long time, remove it from the phone and store it in a cool dry place.

1. Press and hold the **End Key** to turn off the phone.
2. Lift the bottom of back cover from the notch and remove the back cover as shown below.

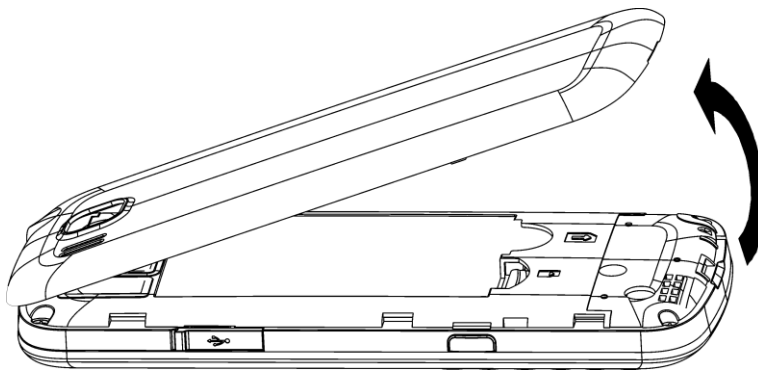

3. Carefully insert the battery making sure the contacts are located against the gold springs.

4. Push the battery down until it clicks into place.

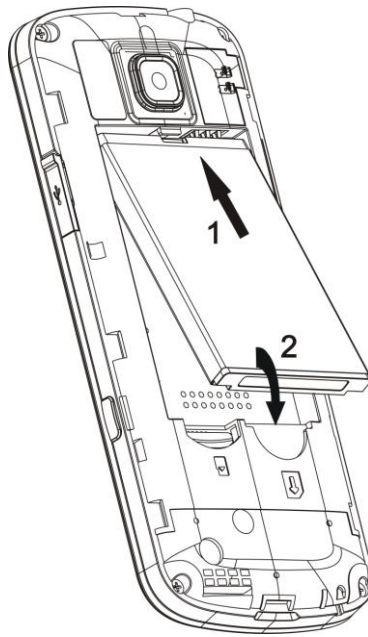

5. Direct the back cover towards the locking catches on top of the phone and press the back cover flatly to lock the cover into its place.



Caution:

- ▶Do not force the back cover into place by pressing on it. Doing so will damage the back cover.

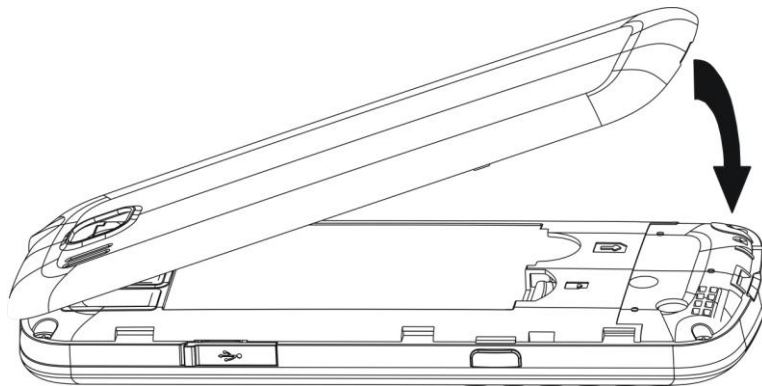

Removing the Battery

1. Press and hold the **End Key** to power off the phone.
2. Remove the back cover.
3. Lift the end of the battery near the bottom of the phone and remove the battery from the phone.

Inserting the SIM card

You can obtain a SIM card from your service provider when you sign on as a subscriber.



Caution:

- ▶Do not bend or scratch your SIM card. Keep the card away from electricity and magnets.

▶Do not touch the metal surface of the SIM card. Doing so could cause information on the card to be lost or destroyed.

▶Disconnect the charger and other accessories from your phone and remove the battery before inserting and removing your SIM card.

1. Press and hold the **End Key** to turn off the phone.
2. Remove the back cover and battery.
3. Hold the SIM card with the metal contacts facing downward and the cut corner at the bottom right.. Insert the card into the card holder and push it until it clicks into position.

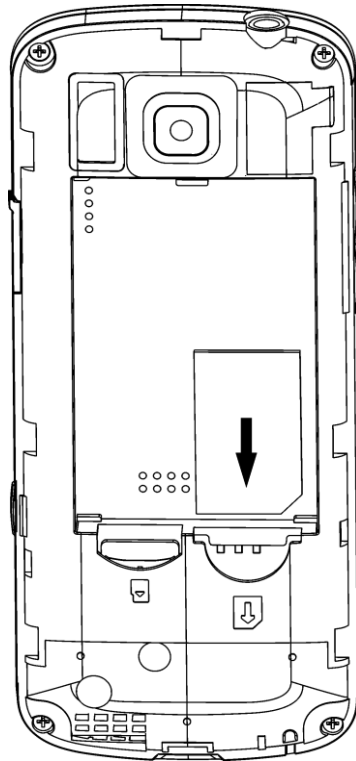

4. Replace the back cover.

Removing the SIM Card

1. Press and hold the **End Key** to turn off the phone.
2. Remove the back cover and battery.
3. Gently remove the SIM card from the card holder.

Inserting the Memory Card

The external memory card gives your phone a very large memory capacity. This allows you to save multimedia data, including images, photos, MP3 audio files, and ring tones. You can also use this memory card to store other files.



Tips:

Your phone can support an external memory card with an up to 8GB capacity.

1. Press and hold the **End Key** to power off the phone.
2. Remove the back cover and battery.
3. Carefully insert the memory card into the memory card slot and place the card into position as shown

below.

4. Re-insert the battery, close the back cover and switch the handset on.

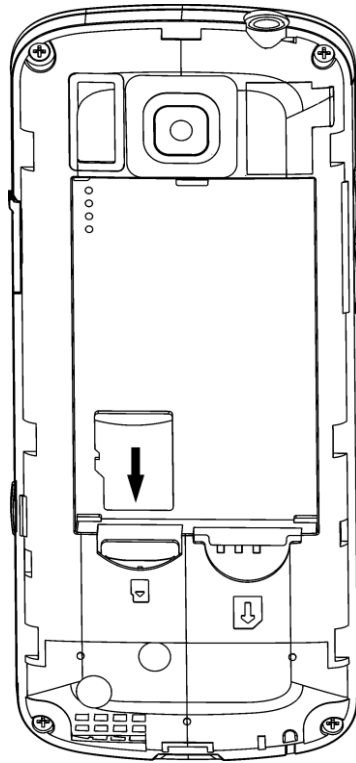

Caution:

Only use approved memory cards for this device. Any use of unapproved memory cards might cause loss of information or damage to your phone.

Removing the Memory Card

1. Press and hold the **End Key** to power off the phone.
2. Remove the back cover and battery.
3. Push the card so it clicks out.
4. Carefully remove the memory card.
5. Re-insert the battery, close the back cover and switch the handset on.



Tips:

- ▶ **Do not remove the memory card while reading or writing to the card. Doing so might corrupt the information on the card or phone. If possible, insert and remove the memory card while the phone is turned off.**
- ▶ **If you want to format the memory card on your PC, make sure you select the FAT Formatting type. If this is not done the memory card might not be identified by your phone.**

Connecting Accessories

You can connect accessories to your phone. These include a headset for answering calls or listening to music, a data cable for transferring information to your PC, and a wrist strap for attaching the phone to your wrist.

Connecting a headset to your phone

Insert the headset connector into the **Headset port**.

Connecting a data cable to your phone

Plug the smaller end of the cable into the **USB connection jack** on the right side of the phone. Insert the USB connector (the larger end of the cable) into the USB port on your computer.

Power On/Off



Notes:

Do not turn your phone on in areas in which wireless phone use is not permitted, or when it could cause interference or danger.

1. Press and hold the **End Key** to turn on the phone.



Tips:

- ▶ **When prompted, enter your PIN (Personal Identification Number) code or handset code and press the OK Key.**
 - ▶ **The PIN code is the password provided by your network service provider. You cannot use the SIM card without it.**
 - ▶ **When the PIN code or handset code is accepted, the phone automatically searches for the network. After a few seconds, your phone displays standby mode.**
2. To turn off the phone, press and hold the **End Key** from standby mode.

Charging Your Phone

Your phone uses a rechargeable battery. When you first unpack the phone, the battery is not fully charged, but there might be enough power to turn on the phone. You should flatten the battery by using all of the available power before charging the battery for the first time.

1. Open the USB port cover.
2. Insert the charger's USB adapter into the USB port.
3. Plug the charger into a standard AC wall outlet.

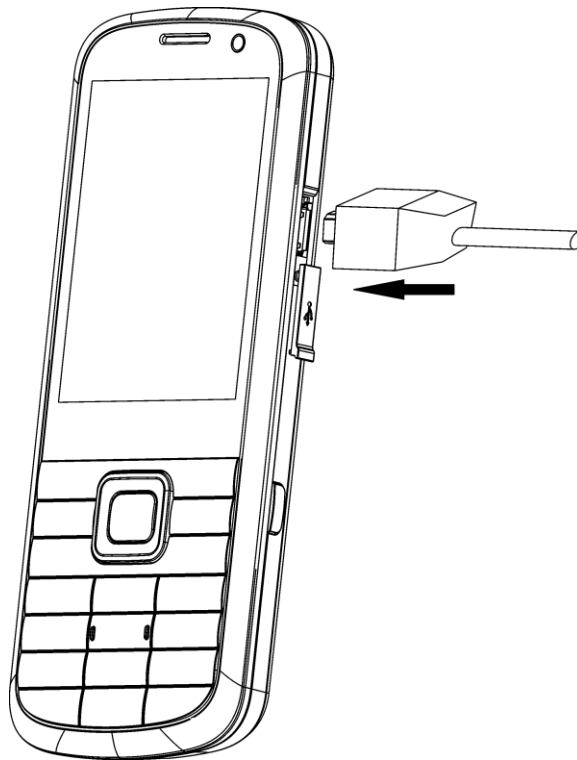

4. When the battery is fully charged, unplug the charger and disconnect it from the phone.



Notes:

- ▶ Make sure the adapter's connector is inserted correctly. Do not force the connector into the port.
- ▶ The battery will remain fully charged for 3 to 4 hours.
- ▶ Only use the charger provided by the original provider. Using an unapproved charger might be dangerous and violate the authorization and warranty rules of the phone.
- ▶ If the phone is used too often when the battery is low or not used for a long time, the screen may not display the charge indicator until the battery has been continuously charged for 10 to 40 minutes.
- ▶ To get the maximum performance out of your battery, it is recommended that you completely charge the battery before using the phone for the first time. A new battery's full performance is only reached after three complete charge and discharge cycles have been finished.
- ▶ When the battery is fully charged, unplug the charger and disconnect it from the phone.
- ▶ You can use the provided charger or the USB data cable to charge the battery.
- ▶ Charging is only possible within a temperature range of 0° C to 45° C.

Quick Operation

Standby Mode

After power on the phone, when the name of network is displayed on the screen, the phone is in the standby mode and ready for use.

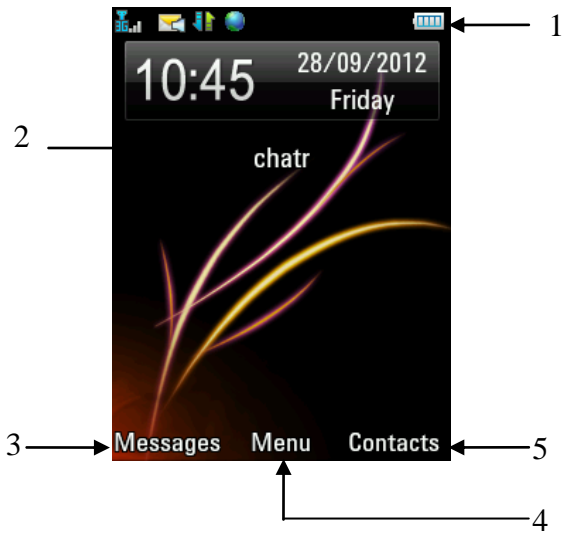

1	Indicators
2	The name of the service provider
3	The function for the Left Soft Key
4	The function for the OK Key
5	The function for the Right Soft Key

Navigation Keys

Use the **Navigation Keys** to access menu shortcuts, move around the **Main Menu**, and move the cursor.

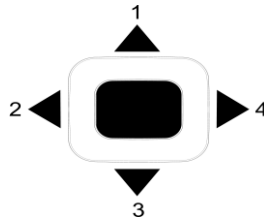

1	Shortcut to Recent Call .
2	Shortcut to Calendar .
3	Shortcut to Contacts .
4	Shortcut to Multimedia .

Soft Keys

The two keys at the top of the keypad are the **Left** and **Right Soft Keys**. They are used to select the options shown at the bottom of the display. The options vary depending on the application/function being used.

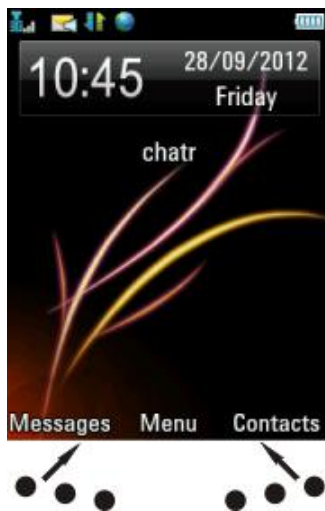

Back and Exit Keys

Press the **C Key** to go back one step or press the **End Key** to return to the **Main Menu** or standby mode.

Basic Operation

Menu

In standby mode, press the **OK Key [Menu]** to show the **Main Menu**.

Tools

The available Tools include **Bluetooth**, **Calendar**, **Alarm**, **Stopwatch**, **World Time**, **Calculator**,

Converter, and **GPS**. For example, you can connect your phone to another Bluetooth device using Bluetooth.

Browser

You can use your phone to get the latest information from the Internet. However, internet access might require registration with your service provider.

The browser displays the preset option when it is started. Browser settings might be specified/pre-assigned by the service provider.

Games & Apps

You can download the applications or games to your phone.

Contacts

You can store contacts with a variety of phone and fax numbers and additional address details. The phone can store up to 500 entries. The capacity of the phone book on your SIM card depends on the type of SIM card supplied by your service provider.

Messages

The SMS (Short Messaging Service) allow you to send text messages and manage the messages that you send and receive.

You can also send and receive MMS (Multimedia Message Service) messages. MMS enables you to send messages containing images, sounds and texts. Contact your service provider for more information and availability. You might need to register separately for this service.

Recent Call

You can check the phone numbers of missed, received, and dialed calls.

Multimedia

You can take photos or videos using the camera, record audio, listen to the radio, etc.

File Manager

File Manager can help you to organize your files in folders.

If the memory card is inserted, folders/files stored in it are organized separately.

Settings

You can adjust settings or personalize your phone.

Camera

You can take photos or videos using the camera.

Navigating Your Phone

The phone's features, various functions and settings are organized into menus and submenus.

1. In standby mode, press the **OK Key [Menu]** to show the **Main Menu**.
2. Use the **Navigation Keys** to scroll up, down, left or right and select a menu. For example, you could scroll to **Settings**.
3. Press the **OK Key** to display the menu. In this example the **Display** tab is displayed.

-
4. Press the **Up Key** or **Down Key** to scroll to a submenu. For example, you could scroll to **Backlight duration**.
 5. Press the **OK Key** to confirm the selection.
 6. Press the **Up Key** or **Down Key** to scroll to an option. For example, you could scroll to **Screen half light**.
 7. Press the **Left Key** or **Right Key** to scroll to an option. For example, you could scroll to **15 seconds**.
 8. Press the **OK Key [Save]** to confirm the selection.



Tips:

- ▶ **If a number is shown next an option in a menu list, you can access that option quickly by pressing the corresponding number key.**
- ▶ **In this User Manual, the steps for displaying a menu are shown in a condensed form. For example: Settings > Display > Backlight duration > Screen half light > 15 seconds.**
- ▶ **Some options are organized into tabs. Press the Left Key or Right Key to switch to different tabs.**

Setting the Date and Time

1. In standby mode, press the **OK Key [Menu]** to show the **Main Menu**.
2. Select **Settings > Phone > Time and Date** to set the date and time.

Keypad Lock

Use the keypad lock to prevent the keys from being pressed accidentally.

1. To lock keypad manually, press the **OK Key [Menu]**, select **Settings > Phone > Auto Keyguard** and then select **No autokeyguard**.
2. To set the keypad to lock automatically, press the **OK Key [Menu]**, select **Settings > Phone > Auto Keyguard** and select **10s autokeyguard**, **15s autokeyguard**, **30s autokeyguard**, or **60s autokeyguard**. These indicate the delay before the keypad is locked.
3. To lock the keypad, in standby mode, press and hold the *** Key**.
4. To unlock the keypad, in standby mode, press the **OK Key**, then select *** Key**.



Tips:

- ▶ **When the keys are locked, Unlock is shown on the display.**
- ▶ **If a call comes in when the keypad is locked, you can press the Voice Call Key to answer it. When the call is ended or rejected, the keypad locks automatically.**

Getting Help

When you use your phone, there are various ways of accessing help information.

Help in your phone

Help information for some applications has been pre-loaded into your phone.

Help in the User Manual

The User Manual contains help for keys, parts information and instructions for setting up and using the phone.

Text Input

Text Mode

You can input text into your phone using the following input methods: 123, Abc, ABC, abc, and En.

Current Text Mode

When you are in a field that allows characters to be entered, the text input mode indicator is shown in the upper right corner of the display.

Changing the Input Mode

Press the **# Key** repeatedly to select an input method.

Abc/ABC/abc Mode

Press a number key (**2 to 9**) repeatedly until the required character is shown on the screen. Press once to input the first letter on the keypad, press twice quickly to input the second letter, etc.

- Press the **0 Key** to add a space.
- Press the **0 Key** twice quickly to enter 0.

123 Mode

When the input method icon is shown as **123**, you can input numbers directly using the number keys.



Tips:

When using number input, you need to switch to other text input methods if you want to insert a space by pressing the 0 Key.

En

The predictive text method is based on a built-in dictionary and generates words from the combination of letters pressed.

1. Press each key once that corresponds to the letter you want to enter. The letters are shown on the display as they are entered. The list of candidate words changes as each key is pressed.
2. When the candidate words are displayed, press the **Up Key** or **Down Key** to highlight a candidate word and then press the **OK Key [OK]**.
3. Press the **0 Key** to insert a space, or press the *** Key** to select symbols.
4. Press the **C Key** to delete the letter to the left of the cursor. Press and hold the **C Key** to delete all entered text to the left of the cursor.

Special Symbols

1. Press the *** Key**.
2. Use the **Navigation Keys** to select a symbol.
3. Press the **OK Key [OK]**.

Calls

Voice Calls

You can dial the phone number directly, or make the call using contacts, the call log, or the speed dial numbers.

Making a Voice Call

1. In standby mode, enter a phone number.
2. Press the **Call Key** to call the number.
3. Press the **End Key** to end the call.

Making a Voice Call from Contacts

1. In standby mode, press the **Right Soft Key [Contacts]**.
2. Use the **Navigation Keys** to select a contact.
3. Press the **Call Key** to call the number.
4. Press the **End Key** to end the call.

Making a Voice Call from Call History

1. In standby mode, press the **Call Key** to display all calls in the Call History.
2. Press the **Up Key** or **Down Key** to select a number.
3. Press the **Call Key** to call the number.
4. Press the **End Key** to end the call.

Voice Call Options

During a call, you can press the **Left Soft Key [Options]** for more options. The options vary depending on the function you are currently using.

- **Hold /Active:** Put the current call on hold or retrieve the call.
- **End call:** End the current call.
- **Record:** Record the current call. You can also press the **OK Key [Stop]** to stop recording.
- **DTMF off/on:** Enable or disable sending the DTMF tone.
- **Message:** Switch to the **Message** menu during a call.
- **Contacts:** Switch to the **Contacts** menu during a call.
- **Browser:** Browse the internet during a call.

Speed Dial

Making a Speed Dial Call



Notes:

The 1 Key is reserved for the Voicemail phone number.

-
1. In standby mode, press and hold the corresponding number key (**2 to 9**) in the speed dial list to make the call.
 2. Press the **End Key** to end the call.

Speed Dial Settings

1. In standby mode, press the **Right Soft Key [Contacts]**.
2. Use the Navigation Keys to select a contact, press the **Left Soft Key [Options]** and select **Set Speed Dial**.
3. Press the **Up Key** or **Down Key** to select a number.
4. Press the **OK Key [Setup]**.
5. Press the **C Key** to finish the setup and return to the upper menu.

Receiving/Rejecting Calls

When a voice call comes in, your phone rings, vibrates or shows an animated cartoon. (See **Personalize your phone > Profiles**). If the caller uses Calling Line Identification (CLI), their phone number shows on the display.

1. Press the **Voice Call Key** or **OK Key [Speaker]** to answer the call.



Tips:

If you have connected the headset to the phone, you can press the button on the headset to answer the call.

2. Press the **End Key** to reject or end the call.

Adjusting the Volume

During a call, press the **Volume Keys** to adjust the earphone or speaker volume.

Call History

In standby mode, press the **OK Key [Menu]** and select **Recent Calls** to check the call log and the duration of the calls.

Call Settings

Starting Call forwarding

Call forwarding allows you to divert your incoming calls to another phone number. Contact your service provider for more information and availability.

Always

Diverts all incoming calls unconditionally.

when busy

Diverts incoming calls when the line is busy.

when no reply

Diverts incoming calls when the phone is not answered.

When unreachable

Diverts calls when the phone is turned off or is not in an area covered by the service network.

Canceling Call Forwarding

When the **Call divert** function is activated on your phone, you can cancel it if you no longer want to use it.

1. In standby mode, press the **OK Key [Menu]** to show the **Main Menu**.
2. Select **Settings > Calls > Call forwarding > Cancel all call forwarding**, and press the **OK Key**.
3. All divert call settings are cancelled.

Starting Call Waiting

If a call comes in when you are already on a call, you are notified with a call waiting tone. The phone shows the number/name of the waiting call. Contact your service provider for more information.

Starting Call Barring

Call barring allows you to restrict the calls that you make or receive. To change the settings, you need to have a network password from your service provider. Contact your service provider for more information.

Bar all outgoing calls

Calls cannot be made.

Bar outgoing calls (international)

International calls cannot be made.

Outgoing international calls except to home country

When out of the country, calls can only be made to numbers within the current country and to your home country, where your home service operator is located.

Bar all incoming calls

Calls cannot be received.

Bar incoming calls when roaming

Calls cannot be received when you are using your phone outside your home service area.

Cancel all call barring

To cancel the **Call barring** function:

1. In standby mode, press the **OK Key [Menu]** to show the **Main Menu**.
2. Select **Settings > Calls > Call barring**.
3. Select **Cancel all call barring**.
4. Press the **OK Key** and enter the network password.
5. Press the **OK Key** to confirm.
6. All call barring settings are cancelled.

Changing the Call Barring Password

1. In standby mode, press the **OK Key [Menu]** to show the **Main Menu**.
2. Select **Settings > Calls > Call barring**.
3. Select **Change password** and press the **OK Key**.
4. Enter the old password and press the **OK Key**.
5. Enter the new password and press the **OK Key**.

6. Enter the new password again and press the **OK Key**.

Send My Number

This function allows you to send or hide your phone number when making calls. You can also select **Set by network**. The network then chooses whether to show/hide the phone number. This function requires network to support.

Messages

Text Messages

SMS (Short Messaging Service) allows you to send text messages and manage the messages that you have sent and received.

SMS Settings

1. In standby mode, press the **OK Key [Menu]** to show the **Main Menu**.
2. Select **Messages > Settings > Text Msg. Settings**, and press the **OK Key [OK]**.
3. Enter the **SMS centre number**, and select **Expiration Time**, **Delivery report**, and **Cell name display**.

SMS centre number	Enter the SMS center number. Contact your service provider for more information.
Expiration Time	The length of time during which the message center will attempt to deliver the message until it is received.
Delivery report	You can select On/Off to receive or reject a popup message that tells you that the message has been delivered to the recipient.
Cell name display	You can select On/Off to enable or disable this function.

4. Press the **OK Key [OK]** to save and exit.

Sending a New SMS

1. In standby mode, press the **OK Key [Menu]** to show the **Main Menu**.
2. Select **Messages > Create message**, and press the **OK Key**.
3. Enter the recipient's(s') phone number. You can also press the **OK Key [Recipient]** to choose the recipient(s).
4. Press the **Down Key** twice to access the text field.
5. Edit the message.
6. Press the **OK Key [Send]** to send the message.

Inserting template

1. Move the cursor to the Text field.
2. Press the **Left Soft Key [Options]** and select **Templates** to switch to the Message Template.
3. Press the **Up Key** or the **Down Key** to highlight an option.
4. Press the **OK Key [OK]** to select the option.

Receiving an SMS

1. The SMS envelope icon appears in the information bar to indicate that you have received a new SMS. The message alert tone sounds and the phone vibrates depending on the current profile settings. Press the **OK Key** to view the message.
2. To access saved messages:

- a. In standby mode, press the **OK Key [Menu]** to show the **Main Menu**.
- b. Select **Messages > Inbox**.
- c. Press the **Up Key** or **Down Key** to select an SMS.
- d. Press the **OK Key [View]** to view the SMS.

Multimedia Message

MMS enables you to send or receive messages containing images, sounds and text. Contact your service provider for more information.

MMS Settings

1. In standby mode, press the **OK Key [Menu]** to show the **Main Menu**.
2. Select **Messages > Settings > Mul. Msg. Settings**, and press the **OK Key**.
3. Set the parameters.

Retrieval Settings	Automatic: Automatically retrieves the new multimedia message. You do not have to select the notification message before the message is received.
	Manual: Retrieve the new multimedia message manually.
Delivery mode:	Select immediate delivery or defer it for a specified period of time.
Delivery time	Specify a period of time during which to send an MMS when you set After sending in Delivery mode. The maximum delivery time is 99 hours.
Time per page	Set the playing time of each page.
Delivery report	A popup message appears informing you that the message has been delivered to the recipient.
Validity	Configure the validity period of outgoing messages. Sets the period of time during which your network will save your messages.
Anonymous Msg.	Set this to accept or refuse anonymous messages.
Connections	Contact your service provider for more information.
PUSH Message	Set this to accept or reject PUSH messages.

4. Press **OK Key [OK]** to save and exit.

Sending a new MMS

1. In standby mode, press the **OK Key [Menu]** to show the **Main Menu**.
2. Select **Messages > Create message** and press the **OK Key**.
3. Enter the recipient'(s') phone number. You can also press the **OK Key [Contacts]** to choose a contact(s).
4. Press the **Down Key** to the Text field.

5. Select the **Left Soft Key [Options] > Insert** to insert image, audio or video.
6. Select the **Left Soft Key [Options] > Insert > Sub** to insert subject.
7. Enter the title of your MMS message.
8. Press the **Down Key** twice to access the Text field.
9. Edit your message.
10. Press the OK Key [**Send**] to send your message.



Notes:

- ▶ **For an unfinished message, press the Left Soft Key [Options] and select Save to save it to Drafts.**
- ▶ **In Drafts you can complete and resend the message.**

Email

This service enables you to send, receive and manage the Email. Contact your service provider for more information.

Email Settings

1. In standby mode, press the **OK Key [Menu]** to show the **Main Menu**.
2. Select **Messages > Email > Settings**, and press the **OK Key**.
3. Set the parameters.

Mailbox Settings	Select the mailbox from the list.
Automatic Retrieval	Select to not retrieve the Email or retrieve it automatically during a set period of time.
Templates Settings:	There are 10 templates for Email in your phone and you can edit them.

4. Press the **OK Key** to save and exit.

Sending an Email

1. In standby mode, press the **OK Key [Menu]** to show the **Main Menu**.
2. Select **Messages > Email > New Email** and press the **OK Key**.
3. Enter the recipient'(s') Email address or press the **OK Key [Contacts]** to select a contact(s).
4. Press the **Down Key** twice to access **Copy to Field** and enter the recipient'(s') Email address.
5. Press the **Down Key** again to access the Title field and enter the title of your Email.
6. Press the **Down Key** to access the Text field.
7. Edit the Email. You can also do the following:
 - ▶ Press **Left Soft Key [Options]** to select **Attachments, Templates, Insert signature, Save, or My words**.
 - ▶ Press **OK Key [Insert]** to insert Files, New image/audio/video.
8. Press the **OK Key [Send]** to send your Email.

Voice Mail

This service allows voice mail messages to be saved when your phone is busy or out of a service area. Contact your service provider for more information.

Voice Mail Settings

Your voice mail phone number is preset by your service provider. You do not need set it manually.

Receiving a Voice Mail

1. The system sends you a message notifying you that there is new voice mail.
2. In standby mode, press and hold the **1 Key** to access the voice mail service.



Notes:

- ▶ **Contact your service provider for more information on using the voice mail service.**

Message Boxes

- ▶ The **Inbox** folder contains all of your received messages. In this folder you can view your received messages and reply or forward messages to another recipient.
- ▶ The **Outbox** folder contains all messages that were not sent during the last attempt. In this folder you can edit or resend your messages.
- ▶ The **Drafts** folder contains drafts and unfinished messages. In this folder you can complete or resend your messages.
- ▶ The **Sent** folder contains messages that were sent successfully. From this folder you can edit or forward messages to another recipient.
- ▶ The **SIM Inbox** contains messages saved in the SIM card. (This folder is not available for Email.).
- ▶ You can move your received messages from the inbox to **User folders**.
- ▶ You can check the amount of memory available for messages in the **Memory info.** folder.



Notes:

- ▶ **You cannot receive new messages if the message memory is full.**
- ▶ **The total amount of space available for saving messages is determined by the space available on the phone and SIM card.**

Push Messages

Push messages is a formatted SMS that displays a message, giving you the option of connecting directly to a particular URL via the mobile's WAP browser.

Contacts

Contacts

Adding a Contact

You can store contacts with a variety of phone and fax numbers and additional address details.

The phone can store up to 500 items. The capacity of the phone book on your SIM card depends on the type of SIM card provided by your service provider.

Contact Options

1. In standby mode, press the **Left Soft Key [Contacts]**.
2. Press the **Left Soft Key [Options]** to access the submenu list and do following:

Options	Function	
Send message	Send SMS, MMS or E-mail to this contact.	
Voice Call	Make a voice call.	
Add new contact	Add new contact.	
Send Bus. Card	You can send the contact via SMS, MMS, Email or Bluetooth.	
Edit contact	Edit contact information.	
Set speed dial	You can set this contact as speed dial number.	
Delete Contact	Delete current selected contact.	
Advanced	Batch send via Bluetooth	
	SIM Management	Send more contacts via Bluetooth.
	Delete Contact(S)	You can move, copy, or delete contact from the SIM card.
	Default memory	Delete contact(s).
	Speed dial info.	You can select the phone or the SIM card to save your contacts in.
	Service dial number	View the current list of Speed dial.
	Memory info.	View some service numbers, such as Voicemail number. You can not edit these numbers.

Connectivity

Mobile Network Select

Your mobile phone supports to register on network automatically. Contact your service provider for more information. If the phone does not automatically connect to a network, you should attempt to register on network manually.

Connecting to a Mobile Network

Check that the following items are correct:

- There is a valid SIM card in the phone.
- The network signal can be received without a problem.
- The phone's battery has enough power.

Generally the phone searches for the network automatically after it is turned on. When the phone is successfully connected to the network, the name or logo of service provider is shown on the display. If the phone does not connect to the network, please try the following:

1. In standby mode, press the **OK Key [Menu]** to show the **Main Menu**.
2. Select **Settings > Connections > network settings**, set **Preferred Mode** and **Preferred Selection**, the further description is shown in the table below:

Network		Descriptions
Preferred Mode	Automatic	Search for available network automatically.
	GSM	Registered to 2G network manually.
	UMTS	Registered to 3G network manually.
Preferred Selection	Automatic	The phone will search for available network automatically after power on.
	Manual	The phone will list all networks for you to choose from after power on.

These parameters might not be identical to your phone, please check the phone to confirm.

3. Press the **OK Key [OK]** to save.

Bluetooth

Your phone includes Bluetooth, which can be used to connect your phone to a wireless headset. You can also use it to transfer files between your phone and other Bluetooth devices, such as to another phone or to a laptop. Not all applications or devices can be supported because Bluetooth is an open forum and different manufacturers have different standards and implementation.

Enabling Bluetooth

By default Bluetooth is disabled on your phone.

If you enable Bluetooth and turn off the phone, Bluetooth will be disabled. When you turn the phone on, Bluetooth will automatically be enabled.

1. In standby mode, press the **OK Key [Menu]** to show the **Main Menu**.
2. Select **Tools > Bluetooth > Bluetooth** and press the **OK Key [OK]**.
3. Select **Bluetooth** switch or Bluetooth **Discoverable** switch and enter the **My Bluetooth info..**

-
4. Press the **OK Key [OK]** to save the settings.



Notes:

- ▶ **Select On to allow your phone to be found by compatible devices.**
- ▶ **You can send files between your phone and another Bluetooth device.**

My Devices

1. In standby mode, press the **OK Key [Menu]** to show the **Main Menu**.
2. Select **Tools > Bluetooth > My devices**.
3. Press the **OK Key [Search]** to search for available Bluetooth devices.
4. Select a device from the list and press the **OK Key**.
5. To connect to the device, enter the pass code when prompted for permission. After the devices are paired, enter the pass code again to verify it and the device will be added.

Sending Data

Check that the following items are correct:

- Bluetooth is enabled.
 - The paired device must be visible.
1. Select a file, press the **Left Soft Key [Options]** and select **Send > Via Bluetooth**.
 2. Select the aim device from the device list and press the **OK Key [Send]** to send.

Receiving Data

1. Enable Bluetooth.
2. If the paired device tries to send a file to your phone, a popup message is shown on the display.
3. Press the **Left Soft Key [Yes]** to accept the incoming file.
4. Press the **Right Soft Key [No]** to reject the incoming file.

Internet

Setting up the Internet Connection

1. In standby mode, press the **OK Key [Menu]** to show the **Main Menu**.
2. Select **Browser > Settings** to do the following:

Connection settings	Sets the APN. This is preset by your service provider.
Advanced settings	Customize the browser display modes, background music, cache, cookies, etc.
Clear cache	Clear all cache data.
Clear cookies	Clear all cookie information.
Clear history	Delete all input history items.
Certificate	List the root and CA certificates on the phone.

Surfing the Internet

1. In standby mode, press the **OK Key [Menu]** to show the **Main Menu**.
2. Select **Browser > Home Page** to show the preset home page.
 - ▶ Or select **New Link** to enter new URL address manually, and press **OK Key [Link]**.
 - ▶ Or select **Bookmarks** to display a list of stored bookmarks.
 - ▶ Or use **Up/Down Key** to select the previously saved page and press **Select > Link** to access the page.

Entertainment

Your phone allows you to use a camera, video camera, voice recorder, etc. to take photos, shoot video clips, record voice memos, etc.

Pictures

Your phone includes a photo management function. Photos in the phone's memory or on the external memory card can be: browsed, transmitted, set as wall paper, added to slides, moved, renamed, copied and deleted.



Caution:

The preset photos on the phone cannot be transmitted or deleted.

Taking a Photo

Your phone has an integrated digital camera, which allows you to capture images.

1. In standby mode, press the **OK Key [Menu]** to show the **Main Menu**.
2. Select **Camera** and press the **OK Key**.
3. Aim the camera lens at a person/place.
4. Press the **OK Key** to take the photo. And the photo will be saved automatically in **My Pictures**.
 - ▶ Press the **Right Soft Key [Back]** to return to the previous screen.
 - ▶ Press the **Left Soft Key [Options]** to discard the photo, to send the photo via MMS, Email or Bluetooth or to set it as wallpaper.

Viewing Pictures

1. In standby mode, select **Menu > File Manager > Pictures > My Pictures**.
2. Select a photo and press the **OK Key [Open]**.

Music

When you have audio files stored in your phone, you can create a playlist. This allows you to set the order in which the audio files are played.

Playing a Music File

You can use following methods to play a sound file.

1. Select **File Manager** to play a sound file.
 - a. In standby mode, select **Menu > File Manager > Audios > My Audios**.
 - b. Select a sound file and press the **OK Key [Open]** to play it.
 - c. Mark all your desired audios, and create a playlist, then press **OK Key [Open]** to play the audios.
2. Select **Playlist** to play the sound files.
 - a. In standby mode, select **Menu > Multimedia > Music > Playlist**.
 - b. Press the **Up Key** or **Down Key** to select a playlist.
 - c. Press the **OK Key [Play]** to play the sound file.
 - d. Press **Left Soft Key [Options] > Play mode > Normal/One-Repeat/Repeat all/Shuffle**, to choose your desired mode.

Managing a Playlist

1. In standby mode, press the **OK Key [Menu]** to show the **Main Menu**.
2. Select **Multimedia > Music > Playlist** and press the **OK Key**.
3. If a playlist has not been created, press the **OK Key [Add]** to create a new playlist.
4. Press the **OK Key [Play]** to play the sound files in the playlist.

When you create a playlist, press the **Left Soft Key [Options]** for more options:

- **Edit Playlist:** Edit the selected playlist file.
- **New Playlist:** Add a new playlist file.
- **Rename:** Rename the selected playlist file.
- **Delete:** Delete the selected playlist file.
- **Delete all:** Delete all files.
- **Info.:** View the information of the selected playlist.

Video

Your phone allows you to record, store and play video files.

Recording a Video

You can use the Video camera to record video clips.

1. In standby mode, press the **OK Key [Menu]** to show the **Main Menu**.
2. Select **Multimedia > Video camera** and press the **OK Key [OK]**.
3. Press the **OK Key** to start recording.
4. Press the **OK Key** again to pause.
5. Press the **OK Key** again to resume recording.
6. Press the **Right Soft Key [Stop]** to stop recording. And the video will be saved in **My Videos** automatically.
 - ▶ Press the **Right Soft Key [Back]** to return to the previous screen
 - ▶ Press the **Left Soft Key [Send]** to discard the video you have just taken, or to send it via MMS, Email or Bluetooth.

Playing Videos

1. In standby mode, select **Menu > File Manager > Videos > My Videos**.
2. Select a video and press the **OK Key [Open]** to play it.

Streaming URL

TV channels are links to audio or video streaming content that are available through the browser. The streaming content is only available while you are connected to the server, depending on your service provider or available content.

Playing Streaming Media

1. In standby mode, press the **OK Key [Menu]** to show the **Main Menu**.
2. Select **Multimedia > Video > Streaming URL** and press the **OK Key [Select]**.

-
3. Press the **OK Key [Open]** to connect the URL.
 4. When successfully connected, you can watch the streaming media program.

Recorder

This function allows you to record a voice memo. You can also set the voice memo as a ringtone.

Recording

1. In standby mode, press the **OK Key [Menu]** to show the **Main Menu**.
2. Select **Multimedia > Audio record** to start the voice recorder.
3. Press the **OK Key [Record]** to start recording your voice memo.
4. Press the **OK Key [Pause]** to pause the recording.
5. Press the **OK Key [Contin.]** to resume recording.
6. Press the **Right Soft Key [Stop]** to stop recording. And the video will be saved in **My Audios** automatically.
7. After recording a voice memo, you have the following options:
 - a. Press the **OK Key [Play]** to replay the audio.
 - b. Press the **Right Soft Key [Back]** to return to the previous screen.
 - c. Press the **Left Soft Key [Options]** to discard the voice memo, or send the voice memo via MMS, Email or Bluetooth or to replay the voice memo.

Tools

Alarm

You can set the alarm to ring if required.

Calendar

You can access and modify your agenda using the calendar.

Stopwatch

You can use the stopwatch to measure time and take split times or lap times. For example, this can be used for timing a variety of sports.

World Time

You can check the current local date and time for major cities around the world.

Calculator

The calculator allows you to add, subtract, multiply and divide.

Converter

You can use the currency convertor to convert foreign currency to domestic currency.

GPS

GPS allows you to know location details.

Personalize Your Phone

Profiles

1. In standby mode, press the **OK Key [Menu]** to show the **Main Menu**.
2. Select **Settings > Profiles**:

You can set and edit the appropriate profile depending on the current condition.

Basic Settings

1. In standby mode, press the **OK Key [Menu]** to show the **Main Menu**.
2. Select **Settings > Phone**:
 - ▶ Select **Language** to set the current display language.
 - ▶ Select **Time and Date** to set the date, time and display mode.
 - ▶ Select **Missed calls alert** to set the ringtone notification for missed calls.
 - ▶ Select **Shortcut keys** to assign a navigation key as a shortcut to functions, such as the Calendar.
 - ▶ Select **Auto Keyguard** to set the phone's keypad auto lock time or to disable the keypad auto lock.
 - ▶ Select **Phone number** to set your phone number to remind you which SIM card you are using.
 - ▶ Select **Download location** to select the phone's memory or the external memory card.
 - ▶ Select **Master Reset** to reset the phone to the default factory settings.
 - ▶ Select **Auto power on/off** to set power on/off your phone related parameters.

Display Settings

1. In standby mode, press the **OK Key [Menu]** to show the **Main Menu**.
2. Select **Settings > Display**:
 - ▶ Select **Wallpaper** and select a photo saved in Phone or Memory card. This will be used as wallpaper, which is shown in standby mode.
 - ▶ Select **Manage Themes** to change the theme.
 - ▶ Select **Backlight duration** to adjust the backlight duration time.
 - ▶ Select **Brightness** to adjust the screen brightness.
 - ▶ Select **Keypad light** to adjust how long the backlight for the keypad remains on.
 - ▶ Select **Owner name** to input owner name, displayed in standby mode.
 - ▶ Select **Greeting** to input the greeting words which are shown on the display when the phone is turned on.

Connections

1. In standby mode, press the **OK Key [Menu]** to show the **Main Menu**.
2. Select **Settings > Connections**:

- ▶ Select **Network settings** to set preferred mode and preferred selection.
- ▶ Select **Access point settings** to view the access point list.
- ▶ Select **Modem settings** to set modem parameters, you can use data cable to connect handset and computer and use handset as modem. For detailed parameter, please turn to your service provider.
- ▶ Select **Profile connect** to create or edit connection data for service providers.
- ▶ Select **PC connection** to choose the connection method between your computer and phone.
- ▶ Select **USB Mode** to turn on or off the USB function.

Phone Security

Security Codes

Phone Password

Handset password can protect your handset efficiently and avoid illegal usage. If handset password protection is activated, you should input the correct password in handset start-up.

- For new bought handset, the protection function is not activated and the default password is 0000.
- In standby mode, select **Menu > Settings > Security > Activate security codes > Handset code** to start or stop password protection.
- In standby mode, select **Menu > Settings > Security > Change security codes > Handset code** to change handset password. It is suggested to change the password according to your requirement.



Notes:

- ▶ **Please remember the password you set, without it your phone cannot be used normally and you will need to contact your service provider to unlock it.**
- ▶ **Contact your service provider for more information.**

PIN Codes

A PIN code is the personal identification code used by the SIM card. Its purpose is to avoid illegal use of your SIM card. The correct PIN code should be entered when the new phone is first turned on, otherwise the phone will only be able to make emergency calls.

- For a new card, the default code is supplied by the service provider.
- In standby mode, select **Menu > Settings > Security > Activate security codes > PIN code** to start or stop PIN code.
- In standby mode, select **Menu > Settings > Security > Change security codes > PIN code** to change PIN code.
- If input wrong PIN code continuously for three times, the handset will lock the SIM card and prompt you to input PUK code to unlock.



Notes:

- ▶ **If you change the PIN code, please remember the new number.**
- ▶ **PIN2 is needed for some settings. Use the same procedure as for the PIN code.**

PUK Codes

A PUK code is the unlock code for the SIM card. When the SIM card is locked, you have to enter the correct PUK code and then enter the new PIN code. The SIM card can then be used normally.

- ▶ A PUK code may be supplied with a new card. Contact your service provider for more information.
- ▶ A PUK code can only be entered 10 times in a row. If you enter the wrong PUK code more than 10 times the SIM card will be locked indefinitely.



Notes:

- ▶ **If a PUK code is supplied with the new card, please store it safely.**

Fixed dial numbers

If you use fixed dial numbers, you cannot dial phone numbers that are not in the FDN list.

FDN List

Allows you to see the list of fixed dial numbers.

Network Unlcok

Allows you unlock the network.

File Manager

Managing Folders

You can create a new folder, rename a folder, check folder attributes and delete unnecessary folders.

Space Management

1. In standby mode, press the **OK Key [Menu]** and select **File Manager**.
2. Select a folder in **Phone** or **Memo. card**.
3. Press the **Left Soft Key [Info.]** to check the space information.

Care and Maintenance

General Care

- Do not allow the phone, battery or accessories to come into contact with liquids or moisture at any time. Do not immerse the phone in any liquid.
- Do not place the phone next to computer disks, credit cards, travel cards and other magnetic media. The information contained on the disks or cards may be affected by the phone.
- Do not place anything in the folded phone.
- Do not paint the phone.
- Do not leave the phone or battery in places where the temperature could exceed 60° C. For example, on a car dashboard or a Windowsill, behind glass in direct sunlight, etc.
- Do not remove the phone's battery while the phone is turned on.
- Do not allow metal objects, such as coins or key rings, to contact or short-circuit the battery terminals.
- Do not dispose of the battery packs in a fire. The handset's Li-ION batteries may be safely disposed of at a Li-ION recycling point.
- Do not put the phone's battery in your mouth. Battery electrolytes may be toxic if swallowed.
- Do not attempt to dismantle the phone or any of its accessories.
- The phone has an internal battery. Take it to a qualified service engineer when battery replacement is required.
- There is a risk of explosion if the battery is replaced with the incorrect battery type. Dispose of the used battery in accordance with the manufacturer's instructions.
- Do not put a battery into a microwave oven, dryer or high-pressure container.
- Do not put the battery in direct contact with an electric outlet or cigarette lighter charger. Use only approved charger units.
- Do not pierce the battery with a sharp object, such as a needle.
- When the battery is thrown away, be sure it is non-conducting by applying vinyl tape to the (+) and (-) terminals.
- Do not disassemble or modify the battery.
- Do not drop, throw, or subject the handset to rough treatment.
- Stop using the battery if abnormal heat, odour, discoloration, deformation or any abnormal condition is detected during use, charge or storage.
- In the unlikely event of a battery leak, keep the battery discharge away from your eyes or skin. If the leakage comes into contact with the eyes or skin, please flush thoroughly in clean water and consult a doctor.
- Do not use a damaged or deformed battery.
- Do not directly solder a battery.
- If the battery's life cycle has expired, remove it from equipment immediately.
- The earpiece may become warm during normal use. In addition, the phone itself may become warm while the battery is being charged.
- When a phone is in vibration mode, the vibration can sometimes cause the phone to move.

-
- Be careful not to place the phone near heat sources (such as a heater) or too close to the edge of a table.
 - Use a damp or anti-static cloth to clean the phone. Do not use an ordinary dry cloth or electrostatic cloth. Do not use chemical or abrasive cleaners as these could damage the casing.
 - Third party equipment: The use of third party equipment, cables or accessories, not made or authorized by the manufacturer, may invalidate the warranty of your handset and adversely affect the phone's safety/operation.
 - Remember to make backup copies of all of the important data on your handset.
 - Remember to recycle: the cardboard packing supplied with this handset is ideal for recycling.



Caution:

There is a danger of explosion if battery is replaced by with the incorrect type. Dispose of used batteries according to the instructions.

Aircraft Safety

- Turn off your phone before the airplane takes off. To protect airplane's communication system from interference, using a mobile phone in flight is prohibited. If you want to use mobile phone before the airplane takes off, you should get aircrew's permission according to the safety regulations.
- If the mobile phone has an automatic timing power-on function, please check your alarm setting to ensure that your phone will not be automatically turned on during the flight.

Hospital Safety

- Switch off your phone and remove the battery in areas where the use of phones is prohibited.
- Follow the instructions given by the respective medical facility regarding the use of phones on their premises.

General Guidelines

- In some countries national law prevents unapproved private copying of copyrighted material. Please check the national legislation of the applicable country concerning the use of such material.
- Many jurisdictions have laws and regulations about taking pictures in public or private areas and regarding the processing and further use of such pictures. The manufacturer encourages its customers to obey all laws and to respect the personal rights of others.
- Please check the roaming agreement availability with your service provider.
- The use of mobile phones is not allowed in some radiation sensitive areas, such as hospitals, research centers and airplanes. The user is responsible for turning off the device. If there is any uncertainty, you should remove the battery from the handset.
- Observe any signs that indicate that you must turn off your phone, such as those near gas stations or explosives and turn off the phone immediately.
- If you have a heart condition, be careful with the settings for call vibration or tone volume.
- Do not allow children to play with the phone, charger or batteries.
- Do not use the phone where blasting is in progress.
- Do not try to make a call while the temperature of charging battery is above 45 °C.
- Take care not to put your phone in the back pocket of your trousers or skirt and then sit on it. In addition, do not put your phone at the bottom of a bag where it may subject to excessive weight or pressure. Doing so may damage the LCD and camera lens and cause them to malfunction.

-
- The operation of some medical electronic devices, such as hearing aids and pacemakers, may be affected if a phone is used next to them. Observe any caution signs and the manufacturer's recommendations.
 - Do not leave the phone discharged or without a battery for a long time. Doing so may cause some data to be erased.
 - Your phone contains metal, which may cause you to itch, or have a rash or eczema depending on your physical condition.

Road Safety

- You must exercise proper control of your vehicle at all times. Give your full attention to driving.
- Observe all of the recommendations contained in your local traffic safety code.
- Pull off the road and park before making or answering a call, if driving conditions require this to be done.
- Check whether local laws and/or regulations restrict the use of phones while driving.
- You **MUST NOT** stop on the hard shoulder of a highway to answer or make a call, except in an emergency.
- Switch off your phone at a refueling point, such as a gas station, even if you are not refueling your own car.
- Do not store or carry flammable or explosive materials in the same compartment as the phone.
- Electronic vehicle systems, such as anti-lock brakes, speed control and fuel injection systems are not normally affected by radio transmissions. The manufacturer of such equipment can advise if it is adequately shielded from radio transmissions. If you suspect vehicle problems are being caused by radio transmissions, consult your dealer and do not switch on the handset until it has been checked by qualified approved installers.

Vehicles Equipped with an Airbag

An airbag inflates with great force. Do not place objects, including either installed or portable wireless equipment, in the area over the airbag or in the airbag deployment area. If in-vehicle wireless equipment is improperly installed and the airbag inflates, serious injury could result.

Third Party Equipment

The use of third party equipment, cables or accessories, not made or authorized by the manufacturer, may invalidate the warranty of your handset and also adversely affect the handset's operation. For example, use only the manufacturer's power cable supplied with the AC charger.

Emergency Service



Notes:

Emergency service numbers vary by country. They help you to get emergency service from the operator.

To make an emergency call in any country:

1. Ensure that your handset is on and in service.
2. Press the **End Key** as many times as needed to clear the display and ready the device for calls.
3. Enter the local emergency number for your current location, for example, 112.

-
4. Press the **Call Key** to dial the number. Follow the instructions you receive and do not end the call until told to do so.

When the SIM card is not inserted or when the dial lock function is on, press **Right Soft Key [SOS]** and then enter the official emergency number for your present location. Press **Call Key** or **OK key [Call]** to dial the number.



Notes:

- **Tell the operator which service you require: Police, Ambulance, Fire Brigade, Coastguard or Mountain Rescue Service. Tell them where you are and remain stationary to maintain contact if possible.**
- **Due to the nature of the cellular system, the connection of emergency calls cannot be guaranteed. You should never rely solely on any wireless device for essential communications, such as medical emergencies.**

Declaration of Conformity

We declare under our sole responsibility that the product(s) detailed in this manual, and in combination with our accessories, conform to the essential requirements of European Union Directive 1999/5/EC Radio and Telecommunications Terminal Equipment Directive requirements 3.1(a), 3.1(b), 3.2.

Privacy Information

Camera usage and photo/audio/video recordings carried out with the phone can offend the confidentiality of the subjects. The user therefore is held to respect legislation in matters of confidentiality and remains the only responsible subject in the case of eventual violations of the enforced norm.

Copyright Notice

The video/audio recordings you make/download are protected by copyright laws. They are for personal use only and must not otherwise be used without the permission of the copyright owner.

IC compliance

Operation is subject to the following two conditions: (1) this device may not cause interference, and (2) this device must accept any interference, including interference that may cause undesired operation of the device.

This Class B digital apparatus complies with Canadian ICES-003.

This Category II radiocommunication device complies with Industry Canada Standard RSS-310.

IMPORTANT NOTE:

IC Radiation Exposure Statement This EUT is compliance with SAR for general population/uncontrolled exposure limits in IC RSS-102 and had been tested in accordance with the measurement methods and procedures specified in IEEE 1528. This equipment should be installed and operated with minimum distance **1.5cm** between the radiator & your body. The highest SAR value is **1.08** W/kg for the model phone as reported to the IC.

IC: 5200A-ZTEF160

This device and its antenna(s) must not be co-located or operating in conjunction with any other antenna or transmitter.

The County Code Selection feature is disabled for products marketed in the US/Canada.

Troubleshooting and FAQs

Please check the manual thoroughly before contacting your service provider

Problem	Solution
No incoming ring or alarm tone.	<ul style="list-style-type: none"> ▶ Check the ring tone and ring volume settings under Profiles. ▶ Check that the phone is not muted (press and hold the # Key).
(No) keytones when pressing keys.	<ul style="list-style-type: none"> ▶ Check the key tone settings in the current profile.
How do I extend the incoming ring time?	<ul style="list-style-type: none"> ▶ This is not a phone setting. Contact your service provider for more information on extending the ring time.
A phone number cannot be dialed.	<ul style="list-style-type: none"> ▶ Check for network coverage. ▶ Check whether any call restrictions are set.
Short messages cannot be sent or received.	See Text Msg. Settings and check that the SMS centre number is correct. Contact your service provider for more information.
MMS messages cannot be sent or received.	Your subscription does not include data services. Contact your service provider for more information.
My phone is slow to respond, and has storage problems.	<ul style="list-style-type: none"> ▶ Restart your phone every day to refresh the memory. ▶ Delete or archive old SMS messages and other content using Master reset.
The battery discharges quickly.	Possible network coverage issue. Check the signal strength. With only 1 or 2 bars, the battery has to work harder to maintain contact with the network. Limit Multi-Media and Bluetooth usage to save power. The battery may be worn out and need to be replaced.
I cannot charge the phone.	<ul style="list-style-type: none"> ▶ Confirm that the charger is inserted correctly. ▶ Remove the battery, clean the contacts and check that it is inserted correctly. The battery may be worn out and need to be replaced. ▶ Tip: Charge the phone using the supplied USB cable.
How do I enter text in an SMS?	From the Phone Number field, press the Down Key twice to move into the Text field.
How do I change the Ringtone?	Edit the current profile and select a new tune in the Audios folder.
The phone turns off after charging.	The phone is charging in the off state. Press and hold the End Key to switch the phone ON or charge it in the ON state.
The phone turns on automatically.	An alarm or calendar event will automatically switch the phone on.

Problem	Solution
My phone is not able to connect to other Bluetooth devices.	<ul style="list-style-type: none"> ▶ Enable Bluetooth and set the visibility to Show. ▶ Possible compatibility issues. Manufacturers incorporate different Bluetooth profiles and not all functionality is supported.
How do I transfer pictures via Bluetooth to a photo printer (e.g., Kodak)?	<ul style="list-style-type: none"> ▶ This is not supported due to different Bluetooth profiles. ▶ Copy photos using PC Client.

Message	Solution
No SIM detected.	Check that a valid SIM card is inserted.
Enter PIN code.	Enter the correct PIN code as supplied by your service provider.
Enter PUK code.	Contact your service provider for more information on how to get a PUK code.
Enter unlock code.	Contact your service provider for more information.
Enter handset lock code.	The default handset lock code is 0000 .

Specifications

The phone specifications are shown in the following table.

Handset Standards	UMTS 900/1800/2100 MHz; GSM/GPRS/EDGE 850/1900 MHz HSDPA,3GPP Rel5,DL 3.6Mbps/UL 384kbps
Dimensions (H×W×D)	116mm × 49 mm × 11.3mm
Weight	Approximately 84g (including battery)
Display	240*320 pixels, 262 K Color TFT QVGA Screen, 2.4 inch
Back camera	3.0 M pixel camera
Extended memory	Up to 8GB memory card
Battery	900mA hours, Lithium ion (Li-ion)
Performance	BMP/JPG/GIF image;(JPEG, GIF87a, GIF89a (still), GIF89a (animated), BMP, WBMP, PNG); 3GP/MP4 video; (MPEG4, AMR-NB ,AMR-WB,AAC,H.263,H.264); MP3/AMR/WAV/ACC/ACC+ audio; Capture Image: up to 2048*1536, 24 b; Capture Video: up to 176*144P; USB2.0; JAVA MIDP 2.1; MMS Video and Picture, Email, Calendar, Speakerphone, Voice Recorder, Bluetooth
Continuous idle time	Up to 160 hours
Continuous talk time	About 280 minutes
Charge time	Approximately 3 hours



Notes:

The phone's talk time and idle time are based on ideal working environments. The use of extended backlighting, browser, and network conditions can reduce battery life and talk/idle time.

Glossary

1. **2G** - Second Generation wireless communication system. 2G system supports low quality voice and low-rate packet-data service. 2G refers to GSM in European countries, and CDMA in America.
2. **3G** - Third Generation wireless communication system. 3G is the next generation wireless communication system that offers real-time video streaming services and high-rate packet-data service. 3G is also known as UMTS (Universal Mobile Telephony System).
3. **Access point** - Access point refers to a point through which users can connect to the network so that the users can use the network services.
4. **MMS (Multimedia Message Service)** - A message service for the handset environment, that allows videos, pictures, audio files and text to be sent between phones and dependent on network provider support, to email addresses
5. **Roaming** - Use of your phone when you are outside your home area, when traveling for example.
6. **SIM** - Universal Subscriber Identity Module. Your SIM is provided by service provider. It carries the authentication and service grade data for the service provider as well as user-specific data such as Contacts and SMS.
7. **Voice/Video mail** - An answering service that automatically answers your calls when you are not available. Others can leave either voice or video messages for you with this service.