

V9C-1 , make it possible

Quick Start Guide

### LEGAL INFORMATION

Copyright © 2011 ZTE CORPORATION.

All rights reserved.

No part of this publication may be excerpted, reproduced, translated or utilized in any form or by any means, electronic or mechanical, including photocopying and microfilm, without the prior written permission of ZTE Corporation.

The manual is published by ZTE Corporation. We reserve the right to make modifications on print errors or update specifications without prior notice.

Version No. : R1.0

Edition Time : 2011.8.9

Manual No. : 079584503638

CE 1588

### Overview

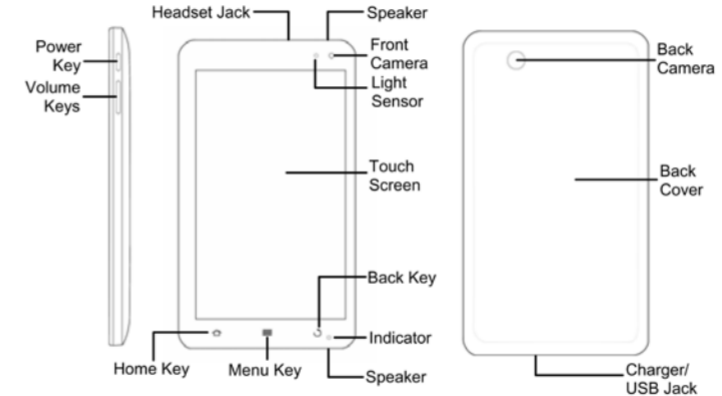

**ZTE CORPORATION**

NO. 55, Hi-tech Road South, ShenZhen, P.R.China

Postcode: 518057

<http://www.zte.com.cn> [mobile@zte.com.cn](mailto:mobile@zte.com.cn)

Service Hotline: +86-755-26779999

The information on the package is only for your reference. Images are for your reference only. Please check the product model before purchasing. ZTE reserves the rights to change specifications and parameters of the products without further notice.

## Before Getting Started

For more information, please read the user manual stored in the preinstalled microSD card.

1. Insert the SIM card



2. Insert the microSD card (may already be inserted)



3. Install the battery



**Notes:** microSD logo  is a trademark of the SD Card Association.

4. Replace the cover

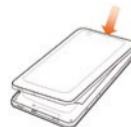

5. Charge up



## Powering On & Off

- To power on your device, hold **Power Key**.
- To power off your device, hold **Power Key** to get the phone options, select the Power off option, and then tap **OK**.

## Switching Your V9C-1 to Sleep Mode











Sleep Mode suspends your device to a low-power-consumption state while the display is off to save battery power. Your device also goes into Sleep Mode automatically when you leave it idle after a certain period of time.







Press **Power Key**.

## Waking Up Your V9C-1 from Sleep Mode

- Press **Power Key** to activate your screen display.
- Drag the unlock icon to the right.

## Product Safety Information

	Read the Safety Information section on this page.		Do not use while re-fuelling.
	Do not use hand-held while driving.		This device may produce a bright or flashing light.
	Small parts may cause a choking hazard.		Do not dispose of it in a fire.
	This device may produce a loud sound.		Avoid contact with magnetic media.
	Keep away from pacemakers and other personal medical devices.		Avoid Extreme Temperatures.

	Switch off when instructed in hospitals and medical facilities.		Avoid any contact with liquid, keep it dry.
	Switch off when instructed in aircrafts and airports.		Do not attempt to disassemble.
	Switch off in explosive environments.		Do not rely on this device for emergency communications.
	Only use approved accessories.		